

Congratulations and thank you for choosing SONO floors! Your new floors are among the most technologically advanced, long-lasting and easy-to-maintain floors available, not to mention simple, quick and clean to install. This installation guide outlines everything you need to know to properly install your SONO floors. If you have questions at any time during the installation process, please contact your specialty floor covering retailer or call our support line at 888.255.3412.

1. GENERAL INFORMATION

A. Intended Use

SONO floors are intended for indoor use only and can be installed in any room as long as it does not have in-floor drainage. All SONO floors have been designed to withstand the requirements of the busiest households as well as light commercial applications. SONO is not recommended where the floor might experience temperature extremes beyond -40°F (-40°C) or greater than 150° F (65°C). The occupied use temperature range is assumed to be between 50°F (10°C) and 100° F (38°C). If you are installing floors in a commercial environment, please read the warranty documentation specific to your product to determine its suitability.

B. Floating or Glue-Down

SONO floors are designed to be a floating floor system; however, it is acceptable to install as a glue-down product. If you do wish to glue-down SONO please contact customer support and request the *SONO Glue-Down installation Instructions*.

A floating installation means the floor is assembled using the MegaLoc system and should not be glued, nailed or attached in any way to your existing subfloor. Care should be taken to leave appropriate spacing between walls and flooring (refer to Before You Begin, Section 3C, for expansion spacing).

C. MegaLoc™ Installation System

All SONO floors are equipped with MegaLoc™, an advanced glueless installation system. Each plank is milled with a patented tongue and groove design that allows for them to be connected without the use of glue. You will find that MegaLoc™ is simple to use,

quick to install and you won't require any flooring specific tools to install your floor.

D. Precautions

- Never tap SONO flooring during installation.
- Never use tools designed for other flooring installation systems.
- SONO is a finished floor and so should never be refinished (wax, polish, etc.)

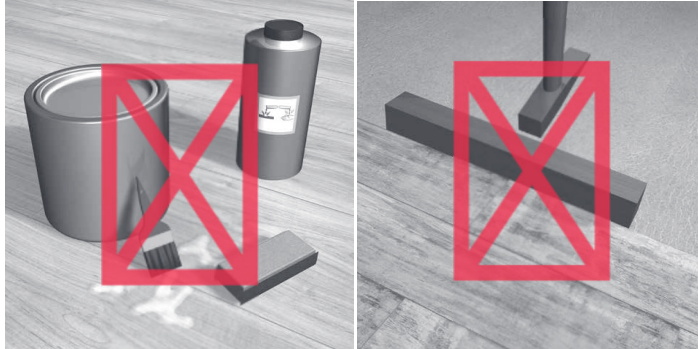

2. TOOLS AND MATERIALS

Materials

- SONO floors
- SONO approved underlayment
- SONO approved vapor barrier (if required (see Section 3H); most underlayments are equipped with a vapor barrier pre-attached)
- SONO transitional moldings (if required)

Tools

- Measuring tape
- Carpenter's square
- 2" (51mm) wide moisture resistant adhesive tape
- Utility knife
- Safety glasses & Dust mask (NIOSH-designated)
- Pencil/marker
- Pull bar
- Expansion gap spacers
- Non-marking seam roller
- Power saw (any of the following): Not required if using the score and snap method.
 - Table saw
 - Miter saw
 - Circular saw
 - Jigsaw
- Handsaw or door-jamb saw

3. BEFORE YOU BEGIN

A. Calculating Flooring Material Requirements

- Measure the length and width of the room where you will be installing SONO floors and multiply them together to determine its area.
- Add 10% to the room's area to determine the square footage of flooring, underlay, and vapor barrier that you will require.

NOTE: for rooms with angled walls or more complicated layouts, 15% is recommended.

B. Acclimation

Before installation, SONO should be acclimated to the same conditions as the room in which it is being installed. If SONO has been stored in conditions similar to the install location, then acclimation is not required. Otherwise, cross-stack unopened cartons in the area where they will be installed and away from outside walls, heat and air conditioning vents and allow for 24-48 hours for the floors to acclimate before opening the cartons. Installation temperatures should be a minimum of 60°F (15°C) with a maximum humidity of 75%.

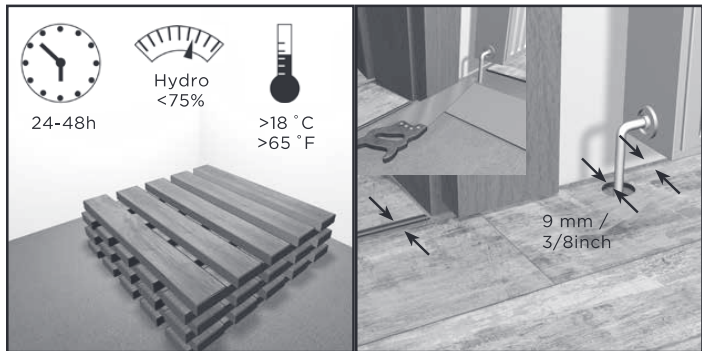

C. Expansion Space

It is necessary to leave a 3/8" (9mm) expansion space around the perimeter of the room and all other objects (e.g. toe kicks, plumbing, etc.). The expansion space will be covered by the wall base or quarter round once the floor is installed.

For specific instructions on Cabinets and Islands please see section 5B.

D. Maximum Room Size

SONO floors can be installed in a single room up to 100 linear feet (30m) in length or 100 linear feet (30m) in width. Installations in rooms that are over 100 linear feet in length or width must use transitional moldings (Refer to Moldings, Section 9, for more information).

E. Doorways

The installation of T-moldings in doorways is not a requirement for SONO, provided the total area of the installation follows all sub-floor and installation requirements.

T-moldings must be used if you would like to change the orientation (plank direction) of the flooring between rooms (i.e. bedroom to a hallway).

F. Installation Layout

As SONO is a decorative product, provided you adhere to the installation guidelines, there are no rules when it comes to the plank layout of your installation. Typically, SONO flooring installations are orientated in the following manner:

- Parallel to the longest wall in the room, or
- Parallel to the main window in the room

G. Cutting Planks

SONO flooring planks can be scored and snapped using most utility blades. Simply score planks and snap to cut. Please always use a straight edge and appropriate safety equipment. It is important to use good quality, sharp blades in order to minimize damage to the planks. Most power saws (e.g. circular saw, table saw, miter saw, jigsaw) as well as hand saws can also be used to cut SONO planks.

NOTE: Sawn planks should always be cut away from the installation area in order to keep debris from affecting the site. Always wear safety glasses and a NIOSH-approved dust mask.

H. Underlayment

SONO floors are designed to be installed over an underlayment. A minimum 14.25 psi (10 t/m²) crush and maximum 1/16 in (1.5mm) thick underlay is required. We recommend the use of SONO Dynamix Prime as this underlay has been specifically formulated to support the installation and use of your SONO floors.

NOTE: Underlayment can have a dramatic effect on the sound and comfort of a floating SONO floor. If either sound or comfort of the floor is of particular concern to you then we would recommend that you invest in an appropriate underlayment.

4. SUBFLOOR PREPARATION

SONO floors can be installed over many types of subfloors as long as they are properly prepared and meet the required criteria outlined below.

A. General Subfloor Preparations & Precautions

- Subfloors must be clean and free of dirt and debris

prior to installation.

- Subfloors must be structurally sound prior to installation.
- Carpet is not a suitable underlay for SONO floors. All carpet, carpet pad and carpet tack should be removed prior to installation.
- SONO floors can be installed in bathrooms, kitchens, and entryways by following the Wet Area Recommendations section of this guide (Section 8).
- Variations in the subfloor flatness should not exceed 3/16" per 10ft (6mm per 3m). Floors must be leveled to meet this specification prior to installation. Level by filling depressed areas with floor leveling compounds and sanding or grinding down any raised areas.
- Installations over radiant heated subfloors are acceptable but the radiant temperature should never exceed 85° F (29° C).

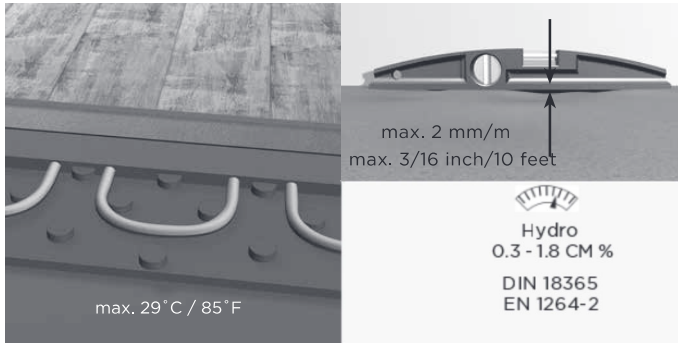

- Radiant heat systems must be operating for a minimum of 3 weeks prior to installation of SONO floors.

B. Concrete

Concrete subfloors must be properly cured and allowed to dry for at least 60 days prior to installation. The maximum allowable moisture emission is 8.0 lbs/1000 ft² per 24 hours (3.91 kg/100 m² per 24 hours) ASTM F1869. Alternatively, a Tramex test can be done in accordance with ASTM F2659 however, recorded values higher than 4.5% require a Calcium Chloride test to verify that the subfloor moisture is appropriate. In Situ probe testing can also be used according to ASTM F2170 and the reading should not exceed 85%.

Test concrete subfloor for moisture prior to installation. To do so:

- Tape 3' x 3' (91cm x 91cm) pieces of polyethylene vapor barrier to subfloor.
- If condensation appears on the film after 24 hours or concrete appears dark in color moisture is

likely present and a Calcium Chloride test must be performed.

- A minimum 6 mil (0.2mm) polyethylene vapor barrier must be used when installing over concrete. Overlap vapor barrier edges by 8" (20cm) and seal with moisture resistant adhesive tape.

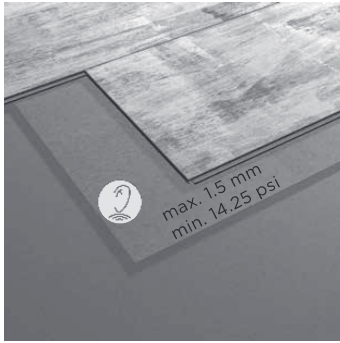

- Run vapor barrier 3/4" (2cm) up wall and trim after wall base is installed.
- Underlay edges should not be overlapped. Butt-end edges together and seal with adhesive tape.

C. Wood

- Wood subfloors must be structurally sound and screwed or nailed to supporting beams.
- Subfloor moisture must be tested prior to installation and should not exceed 12% throughout the installation area.
- Do not install SONO floors over wood subfloors applied directly to concrete.
- If installing floors over a crawl space it is recommended that an 6 mil (0.2mm) vapor barrier be installed. Overlap vapor barrier edges by 8" (20cm) and seal with moisture resistant adhesive tape. Run vapor barrier 3/4" (2cm) up wall and trim after wall base is installed.

D. Vinyl (sheet/tile), Linoleum, Ceramic Tile

- If vinyl, linoleum, or ceramic tile is installed over concrete an 6 mil (0.2mm) vapor barrier must be installed over it. Overlap vapor barrier edges by 8" (20cm) and seal with moisture resistant adhesive tape. Run vapor barrier 3/4" (2cm) up wall and trim after wall base is installed.
- The existing hard-surface floor covering must be well bonded and the surface is flat and smooth.
- Tile unevenness (large grout lines) should be made smooth by applying an overlay such as cementitious patching or leveling compound.
- Existing floors should not be heavily cushioned and not exceed one layer in thickness.

5. ROOM PREPARATION

A. Wall Base/Trim

- Removal of existing wall base/trim is optional. If you decide not to remove your wall base then you will have to install quarter round moldings after installation of the floor is complete.
- Wall base or trim will need to be installed once the flooring installation is complete to cover the expansion space around the perimeter of the room.
- Always nail/adhere wall base and trim to the wall. Never nail/adhere it to the flooring.

B. Cabinets & Islands

- Cabinets can be installed directly over SONO provided that the cabinets are mounted to the wall and that the floor is not pinned by the cabinets. It is recommended when possible that cabinets be installed prior to the installation of SONO.
- Freestanding (floating) islands must weigh less than 300 pounds (135 kg) loaded if they are to be placed on top of SONO.
- Islands heavier than 300 pounds (135 kg) loaded should be installed prior to SONO. Then SONO can be installed, respecting the 3/8" (9mm) expansion gap around the perimeter of the island.

C. Doors/Door Jambs

SONO floors should be installed under door jambs. As such door jambs will need to be undercut accordingly. To do so:

- Use a SONO flooring off-cut and a small piece of underlay to support your saw blade at the correct height for undercutting.

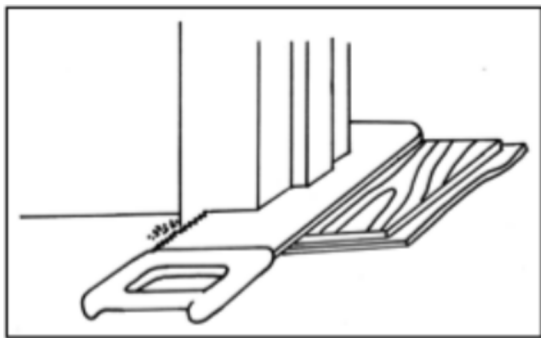

- Check door clearances and make any necessary height adjustments before installing SONO floors.
- Make sure to leave the correct expansion spacing from the wall under the door jamb.

TIP: If possible, it is often easiest to start at the door of the room so that the first plank can be easily slid under

the door jamb.

- In some cases you may have to modify the locking system of the long edge as the door jamb will prevent you from angling the locking system together. To do so, safely remove a small section of the groove on the long edge.

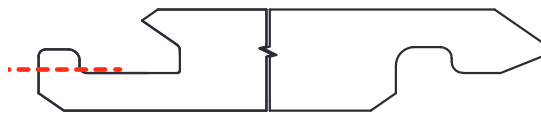

- You can then apply a few drops of industrial strength adhesive into the groove and slide the plank across the floor and into place.

6. INSTALLATION PROCEDURES

- It is recommended that planks be mixed from at least three cartons to achieve the most natural and varied results.
- Inspect every plank for damage and visual defects before installing it. DO NOT INSTALL any planks that are suspect and if required, call our help line at 888.255.3412 or your local retailer.
- The first and last row of the installation should be wider than 3.5" (9cm). To ensure this will be the case, prior to installation:
 1. Measure the width of the room and divide it by the width of the planks you are installing.
 2. If the remainder is less than 3.5" (9cm) cut 3.5" (9cm) from the width of the first row. If this is not possible, simply ensure that both edge planks are as even in width as possible.
- The first and last plank in a row should be a minimum of 16" (40cm) long.
- Stagger the planks from row to row by a minimum of 16" (40cm).
- Prepare the subfloor and room as per the corresponding instructions found in this guideline.
- Use spacers to maintain the 3/8" (9mm) expansion space between the first row and the wall.
- Select a starting corner of the room and work from left to right.

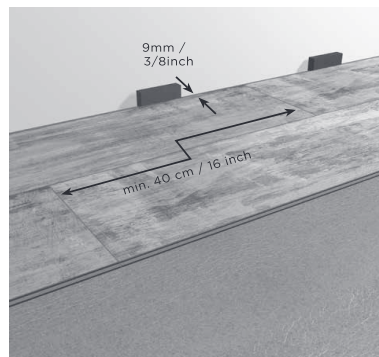

engaging the short edge locking system.

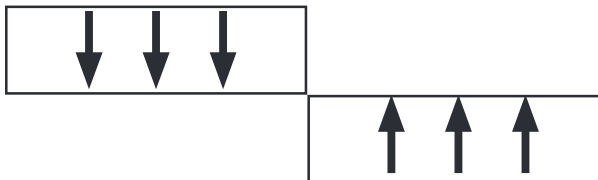

A. Wall Irregularities

Walls are not always perfectly straight. SONO floors will need to be cut so as to fit within irregularities of your walls. To do so:

1. Install a complete, first row of SONO floors (following the Installation Procedures below) and ensure that all long edges of the SONO flooring are aligned flush with one other.
2. Slide the whole row against the wall; you will now notice any wall irregularities (i.e. areas where the wall is not straight).
3. Trace the contour of the wall onto the row of SONO flooring with a pencil or marker. Once traced, uninstall the planks carefully so as to not damage the locking system and cut along the traced line (see Plank Removal Guidelines, Section 7).
4. Re-install the plank leaving the necessary 3/8" (9mm) expansion space.

B. FIRST ROW

Method 1

1. Lay the first plank with the long edge tongue facing the wall.
2. Lift the right side of the second plank to a 30-degree angle and place its short end tongue into the groove of the first plank.
3. Lower the plank to lock the two together.
4. Continue in this manner until the first row is complete. You will have to cut the last plank to complete the row.
5. Use the remainder of the last plank of the first row to start the second row provided that it is a minimum of 16" (40cm) long.

Method 2

1. Lay the first plank with the long edge tongue facing the wall.

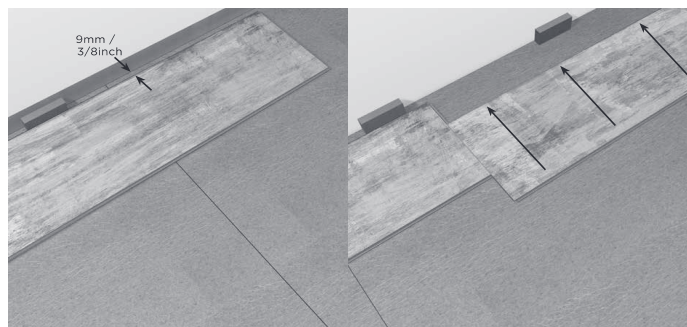

2. Lay the second plank flat on the floor with the short edge joint aligned with the first plank.
3. Slide the planks perpendicular to each other

4. Continue in this manner until the first row is complete. You will have to cut the last plank to complete the row.
5. Use the remainder of the last plank of the first row to start the second row provided that it is a minimum of 16" (40cm) long.

C. ALL OTHER ROWS

1. Install the first plank of the second row by installing its long edge to the previous row's groove in a similar manner as you installed the short edges of the first row (i.e. 30 degree angle and lower).
2. Install the long edge of the second plank to the previous row
3. Before lowering the plank, make sure its short end tongue overlaps with the previous plank's short end groove.
4. Lower the plank slowly (a short oscillating or up-and-down motion may help lower the plank)
5. Apply pressure to the planks short edge starting close to the previous row and then engaging towards yourself across the width so as to activate the MegaLoc™ locking mechanism. A non-marking seam roller can speed up this process.

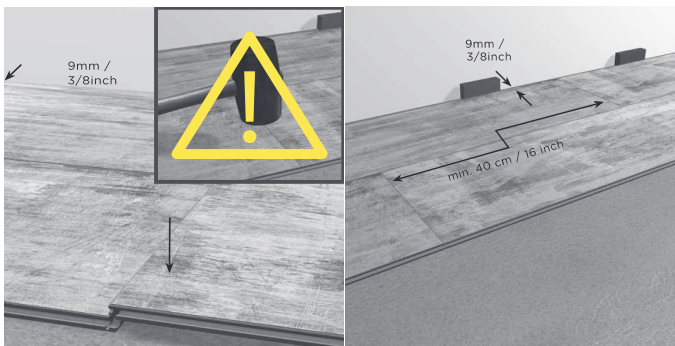

C. COMPLETION OF INSTALLATION

1. Remove all the spacers
2. Install trim moldings
3. Clean floor and inspect

7. PLANK REMOVAL

A. General Removal

To remove planks, simply reverse the installation process. If you plan to re-install them, care should be taken so as not to damage the installation mechanism.

- Uninstall the last installed row all at once by lifting the long edge of the row to approximately 30° in order to disconnect the long edge installation mechanism.

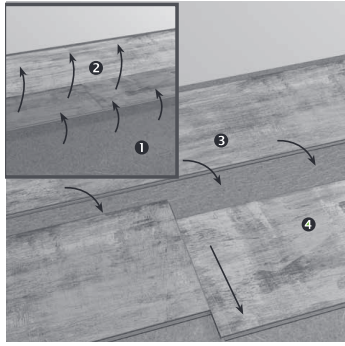

- Once this row has been removed, disconnect each individual plank from one another by starting at the right-most plank and lifting its right end approximately 30° to disconnect the short edge installation mechanism. Alternatively, you can disengage by sliding the planks apart horizontally.

B. Replacement of an Installed Plank Without Uninstalling Adjacent Planks (i.e. Middle of a Room)

The following steps should be taken if a plank in the middle of a room needs to be replaced and it is impractical to uninstall all adjacent rows.

NOTE: After completing the steps outlined below, the new plank will be permanently installed as it will be glued to adjacent planks.

- Select a replacement plank, making sure that it is the right size and style. Ideally, the replacement plank is one that was left over from the original installation.
- With a pencil or marker, accurately draft out the following:
 1. Inside rectangle 1.5" (38mm) from the plank's edges
 2. Mark location for drill holes on corners of inside rectangle and corners of the plank.
 3. Relief cuts at one-third the length of the plank
- Drill 3/16" holes in each of the A and B locations. In location B, drill the hole along the edge of the plank while being careful not to damage the adjacent planks. It is recommended that drill holes are marked with a punch prior to drilling.
- Take a circular saw and set its depth to the plank's thickness.
- Cut along the inside square and remove center

sections. Be sure to protect all adjacent planks so as not to damage them while cutting.

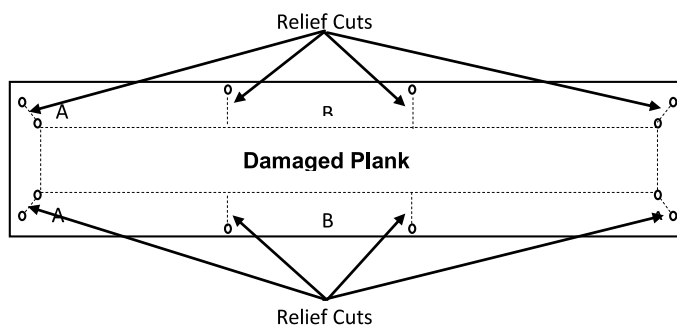
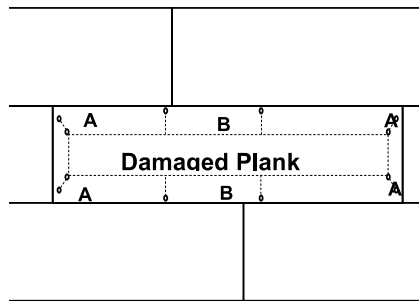

- Make relief cuts to outside of A and B drill holes using the holes for stops so as to avoid damaging adjacent planks.
- Carefully remove the center relief cut sections first.
- Cut towards the corners next and remove the end pieces last.
- Clean and vacuum any debris that has accumulated during the cutting process.
- Prepare the new plank for insertion by removing the grooves on the long and short sides of the plank using table saw, sharp utility knife, chisel or small block plane

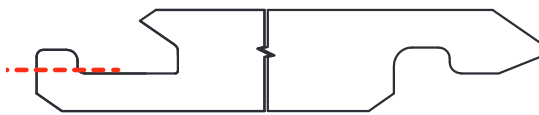

- The replacement plank will now have all grooves removed but tongues intact.



- Apply industrial strength flooring glue or super-glue around the four sides of the new plank.
- Install the replacement plank into the opening created by placing the long end tongue into the adjacent plank's groove and lowering it into

position.

- Remove any excess glue with a damp clean cloth.
- Ensure that all of the joints fit tightly.
- Evenly distribute heavy weights on the new plank for 24 hours.

Note: Damage to planks or performance issues stemming from this procedure will not be covered under warranty. It is recommended that this procedure be performed by a capable professional installer.

8. WET AREA RECOMMENDATIONS

SONO flooring is waterproof but it does not create a waterproof barrier when installed. Special procedures should be followed when installing SONO floors in areas that are prone to moisture (e.g. bathrooms, kitchens, or entryways). As moisture can penetrate through the joints over time, the subfloor must be suitable for damp areas.

- Always install an 6 mil (0.2mm) vapor barrier prior to installing the underlay and SONO flooring.
 - Overlap vapor barrier edges by 8" (20cm) and seal with moisture resistant adhesive tape.
 - Run vapor barrier 1" (2.5cm) up wall and trim after wall base is installed.
- Fill all expansion spaces with 100% silicone caulking (caulking is flexible and will still allow SONO floors to expand and contract).
- Toilets must be removed when installing SONO floors in bathrooms and a 3/8" (9mm) expansion must be left between the flooring edge and the toilet flange. The expansion space must be filled with 100% silicone caulking.

9. MOLDINGS

- Moldings can be attached with metal track (except for quarter round and stair nose) 6d finishing nails or construction adhesive (e.g. Liquid Nails, PL 400). When using adhesive weigh down moldings evenly to ensure proper adhesion. Be careful not to use too much adhesive as it could fill the expansion zone.
- Never fasten moldings directly to the SONO flooring.
- Quarter round moldings and wall base moldings should always be fastened to the wall.
- Ensure that you leave at least 3/8" (10mm) expansion space between moldings and SONO floors.
- If installing over radiant heated floors, always use

construction adhesive to attach the moldings.

- Always pre-drill moldings with appropriate size drill bit to avoid cracking or splitting.

A. Metal Track

The metal track system can be used to install T-moldings, reducers and square nose moldings. Simply screw or nail the track to the sub-floor and snap the molding in place.

B. Quarter Round

Quarter rounds are used to cover the space between the floor and existing baseboards. Nail quarter rounds to the wall, not the floor. Do not force the trim against the floor.

C. 2-in1 Profile

2-in1 moldings are a multi-use product that can act as a T-Molding (two floors of a similar height), Reducer (floors of different height), or End Cap (vertical stop i.e. sliding door)

T-MOLDING

If installing with metal track:

1. Install track first
2. Install SONO floor up to track leaving a 3/8" (10mm) expansion space between the SONO floor and the track.

If installing without metal track:

1. Measure so as to ensure that a 3/8" (10mm) space will be left between the SONO floor and the vertical part of the molding.
2. Install the SONO floors up to the measured point.
3. Install the molding.

REDUCER

If installing with metal track:

1. Install track first
2. Install SONO floor up to track leaving a 3/8" (10mm) expansion space between the SONO floor and track.

If installing without metal track:

1. Measure so as to ensure that a 3/8" (10mm) space will be left between the SONO floor and the vertical part of the molding.
2. Install the SONO floors up to the measured point.
3. Install the molding.

END CAP

If installing with metal track:

1. Cut 0.5" strip of SONO flooring the length of the

trim.

2. Install the strip of SONO against the vertical edge.
3. Install track so that edge of molding is against the vertical edge and resting on the strip of SONO.
4. Install SONO floor up to track leaving a 3/8" (10mm) expansion space between the SONO floor and the track.

D. Stair Nosing

Stair Nosing is used on landings or stairs.

IMPORTANT: Stair Nosing should always be installed with both nails and adhesive so as to ensure a safe and secure fit:

1. If your stair treads have existing bull-nosing remove the bull nosing so as to have a 90-degree angle between tread and riser.
2. Begin at the bottom riser, measure and cut a piece of SONO flooring to fit flush with the sub-floor.
3. Glue the piece of flooring to the riser by applying a 3" serpentine bead of construction adhesive to the back of the flooring.
4. Press the flooring in place.
5. Measure and cut piece of SONO flooring to width of your stair-tread (depending on the depth of your stairs you may need to use more than one piece of flooring).
6. Install the SONO flooring by gluing it to the stair-tread in the same manner as you did the riser.

NOTE: If installing on a landing, install flooring as per the normal procedures, not by gluing it to the sub-floor.

7. Measure and cut the stair nose molding to length.
8. Pre-drill holes on stair nose molding for 6d finishing nails.
9. Adhere stair nose molding to stair-tread with construction adhesive (apply 3/16" bead of adhesive in a 3" repeating serpentine pattern to the back of the stair nose).
10. Anchor stair nose molding with 6d finishing nails.
11. Always ensure you use mechanical (nail) and adhesive (glue) fasteners to secure the stair nose molding.